

REV.	ECN.NO.	MODIFY.CONTENT	DATE
X1		初版发行	5/18'20

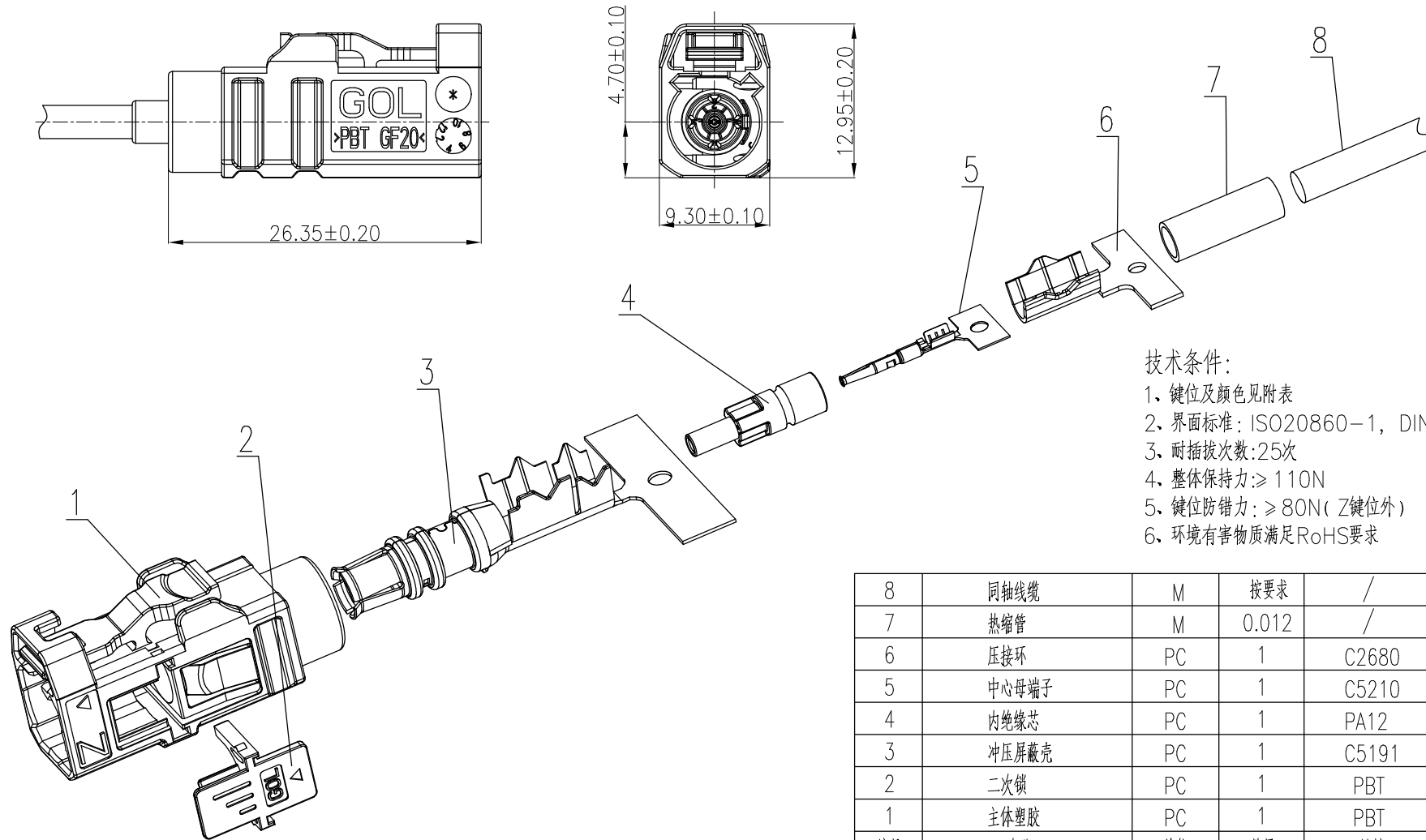

技术条件:

- 1、键位及颜色见附表
- 2、界面标准: ISO20860-1, DIN 72594-1
- 3、耐插拔次数: 25次
- 4、整体保持力:  $\geq 110N$
- 5、键位防错力:  $\geq 80N$  (Z键位外)
- 6、环境有害物质满足RoHS要求





8	同轴线缆	M	按要求	/	RG174
7	热缩管	M	0.012	/	黑色
6	压接环	PC	1	C2680	底镀镍, 表面镀锡
5	中心端子	PC	1	C5210	底镀镍, 接触区表面镀闪金
4	内绝缘芯	PC	1	PA12	本色
3	冲压屏蔽壳	PC	1	C5191	底镀镍, 压接区镀锡
2	二次锁	PC	1	PBT	RAL4006, 交通紫
1	主体塑胶	PC	1	PBT	颜色见下页, 按键位区分
编号	名称	单位	数量	材料	备注
GENERAL TOLERANCE		DRAWN		SCALE	PART NO.
X.±0.30	X.*±1*	CHECKED		N/A	TITLE
.X±0.25	.X*±0.1*	APPROVED		UNITS	mm
.XX±0.20		File NO.	FACV0101H		
.XXX±0.10		REV.			
SHEET	1/2	Q'TY	1	X1	蘇州祥龍嘉業電子有限公司 Goldenconn Electronic Technology Co.,LTD

此文件为双方检验的唯一标准

This document is the only standard for inspection by both parties.

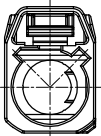
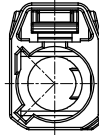
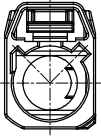
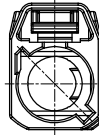
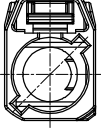
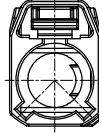
REV.	ECN.NO.	MODIFY.CONTENT	DATE

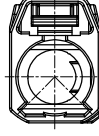
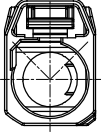
SEE SHEET 1/2

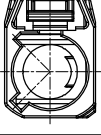
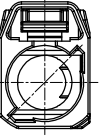
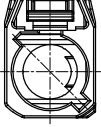
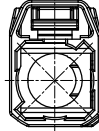
键位	产品料号	颜色	键位图	键位	产品料号	颜色	键位图
A	1FACV01F01RAPS00	墨黑色 Ral 9005		H	1FACV01F01RHPS00	石蓝紫色 Ral 4003	
B	1FACV01F01RBPS00	乳白色 Ral 9001		I	1FACV01F01RWPS00	米黄色 Ral 1001	
C	1FACV01F01RCPS00	信号蓝 Ral 5005		K	1FACV01F01RKPS00	咖喱色 Ral 1027	
D	1FACV01F01RDPS00	酒红色 Ral 4004		L	1FACV01F01RLPS00	胭脂红色 Ral 3002	
E	1FACV01F01REPS00	绿色 Ral 6002		M	1FACV01F01RMPS00	淡橙色 Ral 2003	
F	1FACV01F01RFPS00	深棕色 Ral 8011		N	1FACV01F01RNPS00	粉彩绿色 Ral 6019	
G	1FACV01F01RGPS00	蓝灰色 Ral 7031		Z	1FACV01F01RZPS00	水蓝色 Ral 5021	

键位说明:

1FACV01F01R\*PS00

\*: 键位码

除W代表 I 键位外  
其余字母与键位同

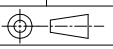
GENERAL TOLERANCE		DRAWN		SCALE	PART NO.	见附表
X.±0.15	X.*±1*	CHECKED		N/A	TITLE	客户图
.XX±0.10	.X.*±0.1*	APPROVED		UNITS	mm	FAKRA直式母端PLUG(不防水)
.XX±0.05		File NO.	FACV0101S			
.XXX±0.03		REV.		蘇州祥龍嘉業電子有限公司		
SHEET	2/2	Q'TY	1	X1	Goldenconn Electronic Technology Co.,LTD	

此文件为双方检验的唯一标准

This document is the only standard for inspection by both parties.